



SPRINTEX® Mini Cooper S
SUPERCHARGER KIT
(254D1001)



INSTALLATION INSTRUCTIONS

Kit Serial # _____
Supercharger Serial # _____
ECU Serial # _____

Table of Contents

INTELLECTUAL PROPERTY USED IN THIS PUBLICATION _____	- 5 -
IMPORTANT INFORMATION _____	- 5 -
SAFETY WARNING _____	- 6 -
CHANGES TO FACTORY SPECIFICATIONS _____	- 7 -
WARRANTY _____	- 8 -
TOOLS AND CONSUMABLES REQUIRED TO COMPLETE INSTALLATION _____	- 9 -
PARTS SUPPLIED _____	- 10 -
SUMMARISED INSTRUCTIONS FOR EXPERIENCED TECHNICIANS _____	- 11 -
DISASSEMBLY INSTRUCTIONS _____	- 12 -
PREPARATION _____	- 13 -
1. DISCONNECT BATTERY _____	- 14 -
2. REMOVE SPLASH SHIELD. _____	- 15 -
3. REMOVE BUMPER COVER. _____	- 15 -
4. REMOVE BUMPER CARRIER. _____	- 15 -
5. REMOVE BUMPER CRUSH TUBE. _____	- 16 -
6. DRAIN COOLING SYSTEM _____	- 16 -
SUPERCHARGER SYSTEM REMOVAL _____	- 17 -
1. REMOVE INTERCOOLER _____	- 17 -
2. REMOVE AIR FILTER HOUSING AND DUCTS _____	- 18 -
3. REMOVE MODULAR FRONT END _____	- 19 -
4. REMOVE THROTTLE BODY _____	- 20 -
5. REMOVE BYPASS AIR ASSEMBLY _____	- 20 -
6. REMOVE ENGINE ACCESSORY DRIVE BELT _____	- 21 -
7. REMOVE DIPSTICK TUBE AND ALTERNATOR _____	- 21 -
8. LOOSEN TENSIONER ASSEMBLY _____	- 22 -
9. SUPERCHARGER REMOVAL _____	- 22 -
INSTALLATION INSTRUCTIONS _____	- 23 -

PREPARATION BEFORE ASSEMBLY	- 24 -
ASSEMBLY	- 27 -
1. FIT TENSIONER ASSEMBLY	- 27 -
2. FIT SUPERCHARGER	- 27 -
3. FIT KNOCK SENSOR	- 28 -
4. FIT ALTERNATOR	- 28 -
5. FIT DIPSTICK TUBE	- 28 -
6. FIT DRIVE BELT	- 29 -
7. FIT INTAKE ASSEMBLY	- 30 -
8. FIT BREATHER AND VACUUM LINES	- 30 -
9. FIT WATER PUMP	- 31 -
10. PLUG IN ELECTRICAL COMPONENTS	- 31 -
11. WATER PUMP RELAY HARNESS	- 32 -
12. WATER PUMP RELAY MOUNTING	- 32 -
13. WATER PUMP WIRING CONNECTIONS.	- 32 -
14. FIT RADIATOR HOSES	- 33 -
15. FIT THROTTLE BODY	- 33 -
16. FIT INLET AIR HOSE	- 33 -
17. FIT AIR BOX ASSEMBLY AND ENGINE CONTROL UNIT	- 34 -
18. FIT INTERCOOLER ASSEMBLY	- 34 -
19. REPLACE MODULAR FRONT END	- 34 -
20. FIT FRONT BUMPER CARRIER.	- 35 -
21. RECONNECT BATTERY	- 36 -
22. FILL AND BLEED COOLING SYSTEM.	- 36 -
23. FIT FRONT BUMPER COVER	- 37 -
PRE TEST-DRIVE INSPECTION	- 38 -
1. PRE-START INSPECTION	- 39 -
ENGINE WARM UP	- 39 -
ROAD TEST VEHICLE	- 39 -

MAINTENANCE INSTRUCTIONS _____ - 40 -

1. SUPERCHARGER DRIVE BELT REPLACEMENT _____ - 41 -

SUPERCHARGER REMOVAL _____ - 42 -

SUPERCHARGER LUBRICATION SERVICE _____ - 42 -

SUPERCHARGER SERVICE _____ - 42 -

Intellectual Property used in this Publication

This document is copyright of Automotive Technology Group Pty Ltd, a company incorporated in Australia. This document may not be re-sold, copied or distributed in any way without prior written authorisation of a director of Automotive Technology Group Pty Ltd.

ATG® has patents for its products or are pending. Any unauthorised copying or modification of the ATG products may result in legal action.

Copyrights / Trademarks:

Sprintex® is a registered trademark of Sprintex® Australasia Pty Ltd, a wholly owned subsidiary of Automotive Technology Group Pty Ltd both companies are incorporated in Australia. Sprintex® has patents for its superchargers. Any unauthorised copying or modification of the system may result in legal action.

Loctite® and Grey Maxx® are a registered trademark of Henkel KGaA, a company incorporated in Germany. Other than commercial supply arrangements, Henkel KGaA do not have any association with ATG®.

RedLine® is a registered trademark of RedLine Synthetic Oil Corporation, a company incorporated in United States of America. Other than commercial supply arrangements, Redline and RedLine Synthetic Oil Corporation do not have any association with ATG®.

Mini, Mini Cooper S, Mini Cooper are registered trademarks of BMW AG Motor Co, a company Headquartered in Munich, Germany (<http://www.bmw.com>)

SAE is a trademark of SAE International (www.sae.org), a global technology information and standards setting resource organisation for the design, manufacturing, operation, and maintenance industry.

Gates is a registered trademark of the Gates Rubber Company, a subsidiary of Tomkins Plc, incorporated in London, United Kingdom. Other than commercial supply arrangements, Gates and Tomkins Plc do not have any association with Sprintex® or Automotive Technology Group Pty Ltd.

IMPORTANT INFORMATION

PRODUCT WARNING

Installation of the Sprintex Supercharger kit on your Mini Cooper S vehicle may void all or parts of Mini Warranty. Customers should consult their Mini dealer for details.

Sprintex makes no representation that installation and use of the Sprintex supercharger kit is legal for public road use worldwide. Customers should check that installation and use of the Sprintex supercharger kit on their vehicle is legal by contacting the relevant statutory authority in their jurisdiction prior to use on roads.

Sprintex supports safe driving. So always remember to observe all speed limits and road rules relevant to your state, city or jurisdiction.

Provided in this installation manual are detailed instructions to the installer on how to install the Sprintex patent pending supercharger kit to the Mini Cooper S vehicle. The instructions are aimed at being simple yet informative, and are aided with well presented pictures to make installations as simple, fast, and problem free as possible. **Please read the entire instruction manual prior to beginning the installation procedure.** Pictures and descriptions may vary slightly from model to model.

It is recommended that all wiring harness connectors, and vacuum hoses are labelled at the time of removal for easy and correct refitting. Some components that are removed and are to be refitted are fragile, and should be stored safely to prevent damage to these components.

Sprintex recommends performing the following vehicle checks prior to installing the supercharger. 1) Check that the factory fuel system is operating correctly. 2) Inspect the factory exhaust catalyst for blocks or damage, and 3) Check fuel quality in fuel tank ensuring that it is not stale or low octane fuel. Replace with a higher octane, Premium Unleaded Gasoline / Fuel as required. It is also recommended to replace the fuel filter if the vehicle has travelled more than 15,000 Kms.

Sprintex will not be liable for any loss, damage, payment, costs, expenses or other liability, not expressly stated in this document. In particular, Sprintex shall not be liable to any person for any consequential, indirect or economic loss or punitive or exemplary damages of any kind.

Sprintex reserves the right to change specifications from time to time and will not be liable to any person for doing so. Sprintex believes that information in this document is correct at time of print. Sprintex limits its liability to the maximum extent permissible at law with regard to the reliance which any person places on anything in this document.

THIS SPRINTEX INSTALLATION REQUIRES THAT YOUR VEHICLE BE FITTED WITH A STANDARD MINI COOPER S FACTORY ECU AND CALIBRATION. FAILURE TO ENSURE THIS WILL AFFECT THE PERFORMANCE AND MAY VOID YOUR WARRANTY.

SHOULD YOU BE UNSURE, RETURN YOUR MOTOR VEHICLE TO YOUR NEAREST MINI DEALER TO ENSURE THE STANDARD CALIBRATION HAS BEEN REINSTATED AND IS OPERATING CORRECTLY.

SAFETY WARNING

No unauthorised service or alteration may be undertaken to the Sprintex supercharger. Installation should be carried out in a workshop which is a safe and ventilated working environment with equipment and procedures compliant with local authority guidelines and legal requirements. Installers should ensure adequate hearing, eye, and physical protection is used at all times during the installation process. Installers should take reasonable precautions to avoid fatigue and closely follow the installation instructions during every installation. Sprintex recommends installation should not be carried out unsupervised. Sprintex, its directors, employees and agents will not accept liability for damage accident or injury resulting from the installation process. Safety warnings are also provided throughout this document.

CHANGES TO FACTORY SPECIFICATIONS

FUEL: MINIMUM 95 OCTANE (91 Octane USA) PREMIUM UNLEADED GASOLINE/FUEL TO BE USED AT ALL TIMES. NEVER ALLOW THE ENGINE TO KNOCK OR DETONATE AS SERIOUS ENGINE DAMAGE MAY OCCUR.

REQUIRED SERVICE: (SEE MAINTENANCE SECTION OF MANUAL)

- 1. INSPECT SUPERCHARGER DRIVE BELT AT EVERY ROUTINE SERVICE AND REPLACE WHEN REQUIRED.**
- 2. DRAIN AND REPLACE SUPERCHARGER OIL EVERY 50,000 km or 30,000 miles. USE REDLINE 75W/90 HIGH PERFORMANCE FULLY SYNTHETIC GEAR OIL OR EQUIVALENT. IT IS CRITICAL NOT TO OVERFILL SUPERCHARGER GEARBOX AS DAMAGE WILL OCCUR. FILL WITH EXACTLY 111 millilitres or 3.77 US fluid ounces.**

Note: Many of the photos shown in this document are of a typical Mini Cooper S vehicle and are similar to a typical Mini Cooper S vehicle.

WARRANTY

1. WARNING

No unauthorised service or alteration may be undertaken to the Sprintex® supercharger system or standard motor vehicle specification. Any modification or alterations from the Sprintex or Mini Cooper S specification will void your **WARRANTY**. (Refer to clause 7 below). The standard Sprintex supercharger system is supplied with a 69mm driven pulley. Use of a smaller or larger pulley will void all warranty.

2. RECOMMENDED MINIMUM FUEL SPECIFICATION

USA	Minimum 91 OCTANE Premium Unleaded Gasoline / Fuel
Europe	Minimum 95 RON Premium Unleaded Petrol
Australia	Minimum 95 RON Premium Unleaded Petrol
New Zealand	Minimum 95 RON Premium Unleaded Petrol

WARNING

ENGINE TUNE IS BASED ON PREMIUM UNLEADED PETROL. SPRINTEX ADVISES THAT THE USE OF ETHANOL BLENDED FUELS MAY CAUSE DAMAGE TO YOUR ENGINE AND THEREFORE USE OF ETHANOL BASED FUELS IS NOT RECOMMENDED.

IN CIRCUMSTANCES WHERE ETHANOL BLENDED FUELS ARE UNAVOIDABLE, SPRINTEX RECOMMENDS THAT THE USER MODIFY THEIR DRIVING STYLE ACCORDINGLY AS WARRANTY DOES NOT EXTEND TO DAMAGE CAUSED BY THE USE OF ETHANOL BLENDED FUELS.

3. SUPERCHARGER BELT & PULLEY

Must be inspected at every routine service and the belt replaced when required.

4. SPRINTEX SUPERCHARGER SYSTEM

The Sprintex supercharger system WARRANTY provides a guarantee against any manufacturing defect in the parts supplied during the warranty period.

The warranty guarantees the replacement of any parts of the supercharger installation which fail as a result of a manufacturing defect in normal operation conditions.

5. WARRANTY PERIOD

12 Months or 12,000 Miles or 20,000 Kilometres (from date of purchase)

6. TERMS OF WARRANTY

Any and all products returned for warranty purposes must be returned freight pre-paid. Sprintex is not responsible for any freight or handling charges on warranted products returned to Sprintex. If the products are warranted, Sprintex will pay for ground shipping charges only to return the parts to the customer. This warranty is for a specific time period only and does not apply to actual operational time or distance. It does not cover products which fail due to alteration, disassembly, accident, racing, misuse, neglect, improper installation, abuse or when used in applications for which they were not designed or approved. Sprintex shall not be liable for non Sprintex products that have been purchased through Sprintex and all warranties will be at the sole discretion of the original manufacturer. Sprintex makes no representation as to the suitability of any products purchased for uses implied by the customer. Removal, installation, transportation, labour, loss of time, inconvenience, destruction of other components and personal damages are not covered. Sprintex shall not be liable for any and all consequential damages occasioned by the breach of any written or implied warranty pertaining to a sale in excess of the purchase price of the product sold.

7. LIMITATION OF LIABILITY

Except to the extent that a warranty is imposed by an applicable law and cannot be excluded, Sprintex® gives no other warranty either express or implied as to any matter whatsoever concerning the Sprintex® Mini Cooper S supercharger system. Sprintex® limits its liability under any such warranty to the maximum extent permitted.

8. WARRANTY CLAIMS must be lodged with your authorised Sprintex approved supercharger service centre and must be accompanied by proof of purchase.

THIS WARRANTY IS NOT TRANSFERABLE



Tools and Consumables Required to Complete Installation

<ul style="list-style-type: none">• Set Metric Wrenches and Sockets	<ul style="list-style-type: none">• Cable Ties	<ul style="list-style-type: none">• Top-up coolant
<ul style="list-style-type: none">• Flat and Philips Screwdrivers	<ul style="list-style-type: none">• Electrical Tape	
<ul style="list-style-type: none">• Solder and Soldering Gun	<ul style="list-style-type: none">• Pipe Sealer, sealant, thread locker	
<ul style="list-style-type: none">• Pliers and Side Cutters	<ul style="list-style-type: none">• Top-up Engine Oil	

PARTS SUPPLIED



1. Sprintex® Supercharger Kit ©
2. Drive Belt Tensioner Assembly
3. Discharge Duct
4. Intake Pipe
5. Water Pump Assembly
6. Water Pump Wiring Loom
7. Ancillary parts
8. Drive belt
9. Tensioner Tool
10. Installation Manual

SUMMARISED INSTRUCTIONS FOR EXPERIENCED TECHNICIANS

DISSASSEMBLY

1. Disconnect battery
2. Remove splash shield bellow engine.
3. Remove bumper cover.
4. Remove bumper carrier.
5. Remove bumper crush tube.
6. Drain cooling system.

PREPARATION AND ASSEMBLY

1. Remove intercooler.
2. Remove air filter housing and duct.
3. Remove modular front end.
4. Remove throttle body.
5. Remove bypass air assembly.
6. Remove engine accessory drive belt.
7. Remove dipstick and alternator.
8. Loosen tensioner assembly.
9. Remove supercharger.
10. Install new tensioner.
11. Install supercharger.
12. Fit knock sensor.
13. Fit alternator.
14. Fit dipstick tube
15. Fit drive belt
16. Fit intake assembly.
17. Fit breather and vacuum lines.
18. Fit water pump.
19. Plug in electrical components.
20. Mount and connect water pump relay.
21. Fit radiator hoses.
22. Fit throttle body.
23. Fit inlet air components.
24. Replace modular front end.
25. Reconnect battery.
26. Fill and bleed cooling system.
27. Replace bumper

MINI COOPER S SUPERCHARGER REPLACEMENT KIT®

SECTION 1

DISASSEMBLY INSTRUCTIONS

SAFETY WARNING

No unauthorised service or alteration may be undertaken to the Sprintex supercharger. Installation should be carried out in a workshop which is a safe and ventilated working environment with equipment and procedures compliant with local authority guidelines and legal requirements. Installers should ensure adequate hearing, eye, and physical protection is used at all times during the installation process. Installers should take reasonable precautions to avoid fatigue and closely follow the installation instructions during every installation. Sprintex recommends installation should not be carried out unsupervised. Sprintex, its directors, employees and agents will not accept liability for damage accident or injury resulting from the installation process. Safety warnings are also provided throughout this document.

Preparation

Ensure that all components required to assemble the supercharger are available. Refer to the Parts Supplied section provided earlier.

Ensure that all required tools are available.

Please read the entire instruction manual prior to beginning the installation procedure.

Ensure vehicle is located in a secure position with vehicle tyres secured and handbrake applied. Sprintex® recommends to avoid injury you should use a vehicle lift or axle stands when the vehicle is required to be lifted for access. Stands should be positioned as per the Manufacturers Owners Handbook.

SAFETY WARNING: Use Personal Protective Equipment such as safety glasses, gloves, etc. at all times and as necessary.

SAFETY WARNING: Allow engine to cool prior to proceeding with disassembly to prevent scalding.

Note: During disassembly and removal of components, take notes and ensure to label and store them safely; this will help with the reassembly.

Note: Many of the photos shown in this document are of a typical Mini Cooper S right hand drive vehicle and are similar to a typical Mini Cooper S left hand drive vehicle.

Caution:

Connect and disconnect battery cables, jumper cables or battery charger only with the ignition switched off

Warning:

Disconnecting the battery may erase fault codes stored in control module memory. Using diagnostic equipment, check for fault codes before disconnecting battery cables. If the malfunction indicator light (MIL) is illuminated.

MIL light.

The MIL light can be found in one of two locations, dependant on the market the vehicle has been built for.

1. The MIL light may be an illuminated **ENGINE** symbol within the speedometer cluster.
2. The MIL light may be displayed as **SERVICE ENGINE SOON** within the Revolution counter.

Please refer to your **OWNERS HANDBOOK** to define which off the above applies to your vehicle.

Note:

Always disconnect the negative battery terminal first. This prevents possible shorting and potential battery damage.

1. Disconnect Battery

The Mini Cooper S battery is located in the centre of the cargo compartment at rear of vehicle, underneath a lift up floor trim panel.

1. First disconnect negative (-) battery cable (A).
2. Lift positive (+) terminal plastic cover (B), then disconnect positive (+) cable.

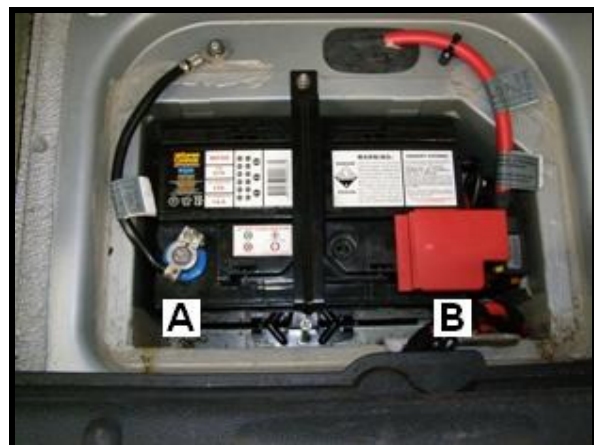

2. Remove Splash Shield.

1. Remove 3 bolts (A) at bottom of front bumper cover.
2. Unlock 2 rear splash shield mounting screws (B).
3. Remove and store splash shield.

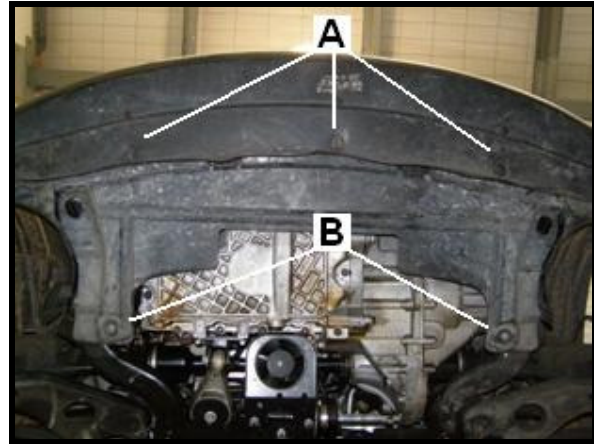

3. Remove Bumper Cover.

1. Remove screws (A) securing bumper cover to Modular Front End.
2. Remove bolts (B) that secure bumper cover to position adjustment bracket from under side.
3. Dethatch bumper cover clips from bumper carrier

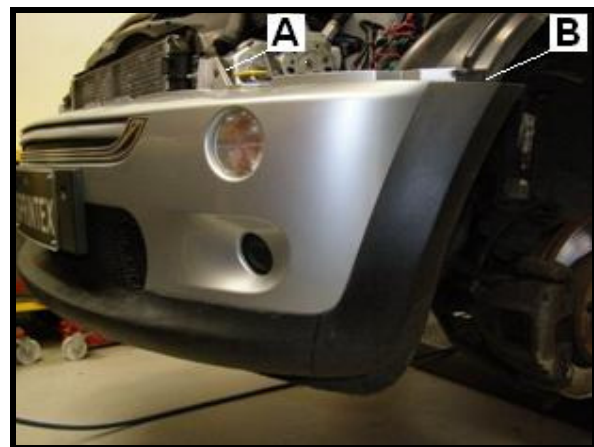

4. Remove Bumper Carrier.

1. Pull out electrical harness for outside temperature sensor through opening in bumper carrier
2. Remove mounting fasteners (A) from vehicle frame bumper support members.
3. Remove nuts (B) from crush tube studs.
4. Remove bumper carrier carefully. Watch for electrical harness connectors or hoses that might become snagged.

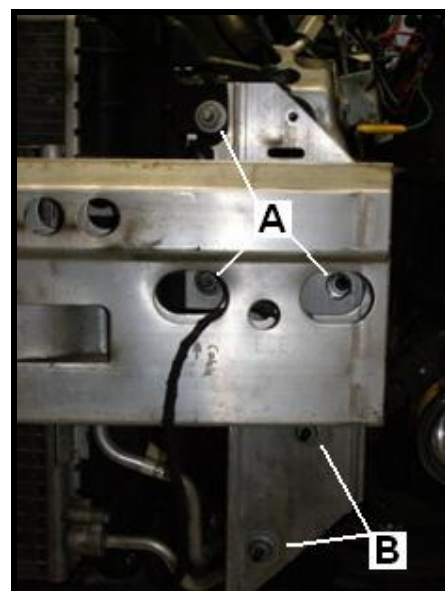

5. Remove Bumper Crush Tube.

1. Working underneath car, remove crush tube mounting bolts (A) at sub frame and modular front end retaining bolt (B) and store parts.

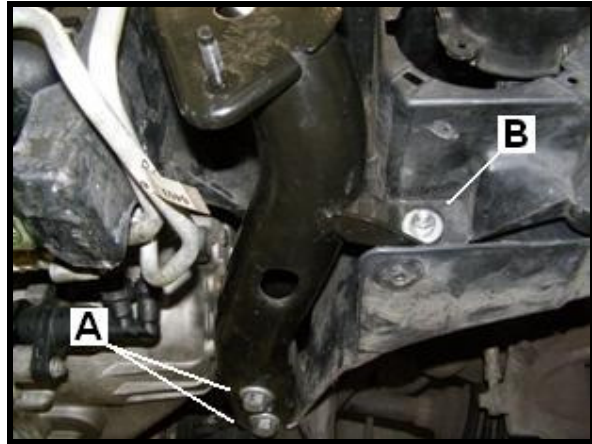

WARNING:

Allow the cooling system to cool before carrying out the following procedure.

6. Drain Cooling System

1. Unscrew the pressure relief cap from expansion tank.



2. Working underneath car, disconnect lower radiator hose and allow coolant to drain into a suitable clean container.



WARNING:

Use extreme care when draining and disposing of engine coolant. Coolant is poisonous and lethal to humans and pets.

Supercharger System Removal

Caution:

Intercooler fins are easily damaged. Be careful working on or around intercooler. Protect intercooler during removal and storage.

Caution:

Cover all painted surfaces before beginning the removal procedure. As an aid to installation, label all components, wires, and hoses before removing them.

1. Remove Intercooler

1. Remove intercooler cover retaining screws (A). Remove cover and store.

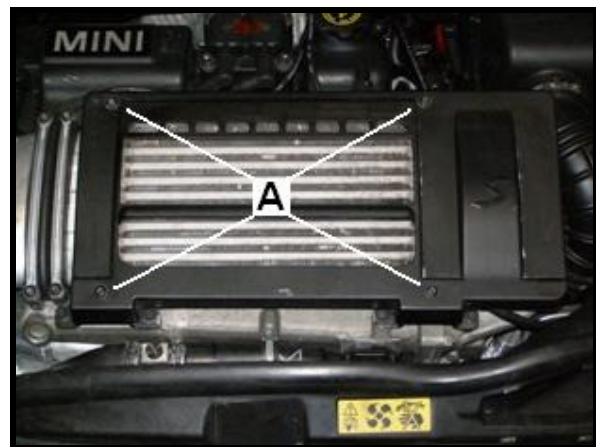

2. Remove intercooler sealing bellows clamping bolts (A). Remove upper clamps.
3. Remove intercooler cover mounting bracket bolts (B). Remove brackets

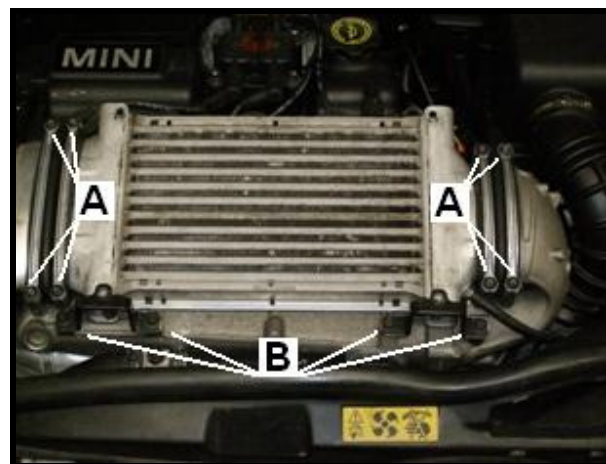

4. Detach right hand sealing bellows first and tilt intercooler up to remove.



2. Remove Air Filter Housing and Ducts

1. Pull up on battery positive connection point (Batt +) to release from right side of air filter housing.
2. Loosen or remove hose clamp (A) and detach outlet hose.
3. Remove air filter housing retaining bolt (B).

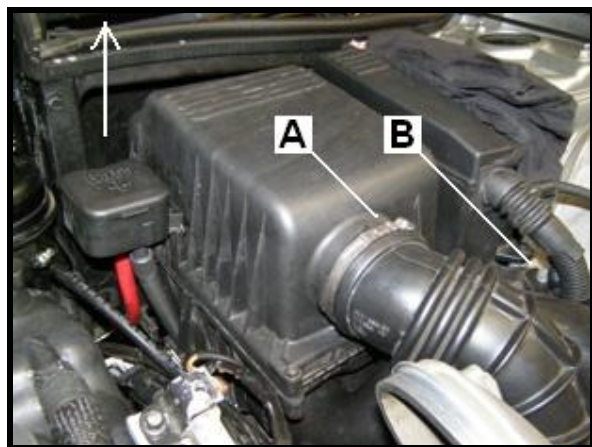

4. Remove control module and store in safe location.



3. Remove Modular Front End

1. Detach radiator upper hose support clamp (A) from intake manifold.
2. Disconnect wiring to horns and radiator cooling fan, remove retaining bolt from air conditioning gassing point.
3. Install two M8 X 100 bolts (B) in left and right bumper support members. Detach inlet air duct (C) from modular front end and slide modular front end forward, on support bolts.
4. Disconnect wiring to fog lamps, feed wires back through modular front end.

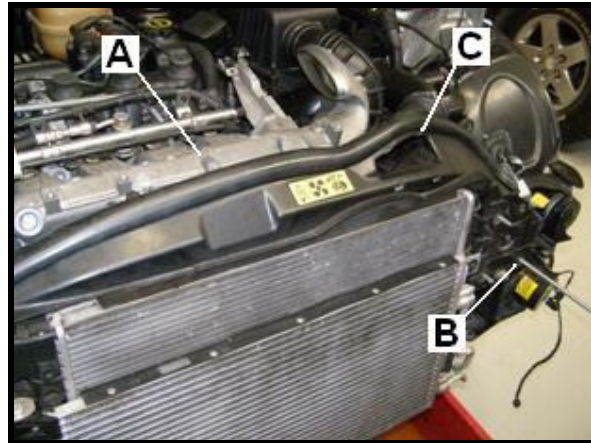

Caution: For ease of component alignment when reassembling front bumper assembly, do not loosen or remove bumper alignment bosses.

5. Remove 2 bolts (A) securing condenser and detach condenser from modular front end.
6. Remove support bolts.
7. Remove and store modular front end.

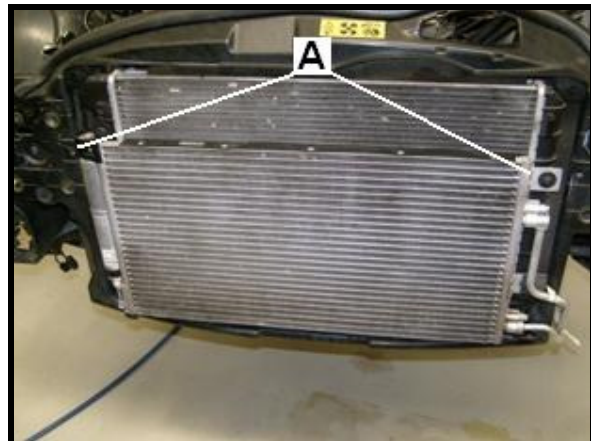

8. Protect rear surface and secure right hand end of condenser to air-conditioning compressor.



4. Remove Throttle Body

1. Remove air filter housing and ducting from engine compartment.
2. Loosen or remove air pipe clamp at throttle assembly. Detach air pipe and store.
3. Disconnect electrical harness connector (A).
4. Detach fuel tank vent line (B).
5. Loosen and remove throttle assembly mounting screws (C).
6. Lift throttle assembly off supercharger intake duct and store.

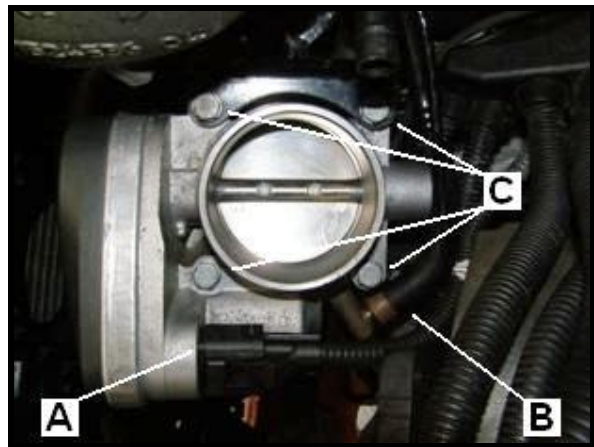

5. Remove Bypass Air Assembly

1. Remove 3 nuts (A) securing inlet casting.
2. Remove bolt (B) securing plastic inlet tube.
3. Detach MAP sensor and brake booster lines at back of plastic inlet tube.
4. Remove assembly and store.

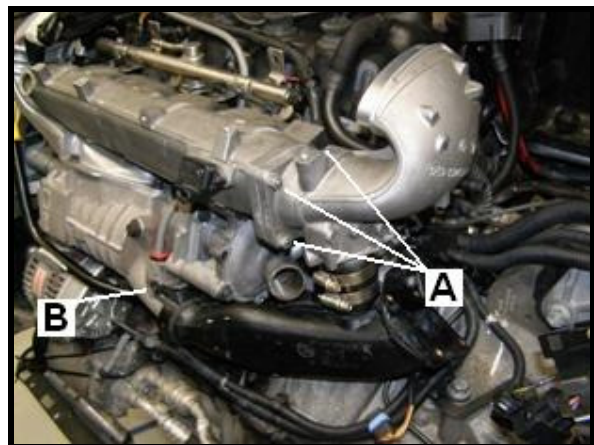

6. Remove Engine Accessory Drive Belt

1. Disconnect vent hoses via quick connectors (A).
2. Straighten retaining tag (B) and slide vent valve off bracket.
3. Disconnect electrical harness connector.
4. Store vent valve.
5. Using special tool, release tension on accessory belt tensioner. Lock into place by securing with screw driver or pin, through hole provided in the tensioner spring inner guide strap.
6. Remove drive belt and store.
7. Remove screw driver or pin and let tensioner relax.

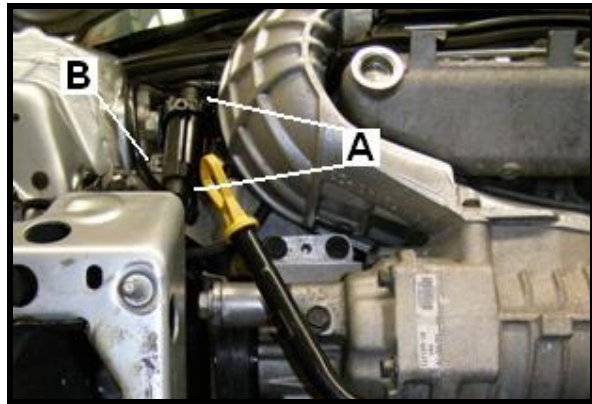

7. Remove Dipstick tube and Alternator

1. Remove bolts (A) securing dipstick tube.
2. Remove dipstick tube and store.
3. Disconnect alternator electrical harness connector.
4. Remove mounting bolts (B) and move alternator with main power cable attached to area in engine bay above gear box.

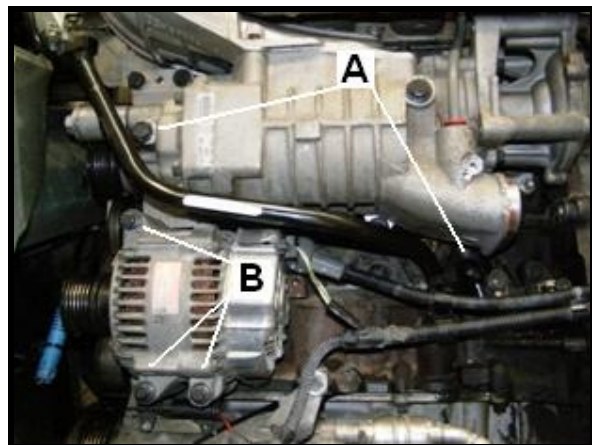

8. Loosen Tensioner Assembly

1. Loosen main bolt securing tensioner to supercharger.
2. Remove 3 bolts (A) securing tensioner to front of engine.

NOTE: Tensioner cannot be removed from engine bay until supercharger is removed.

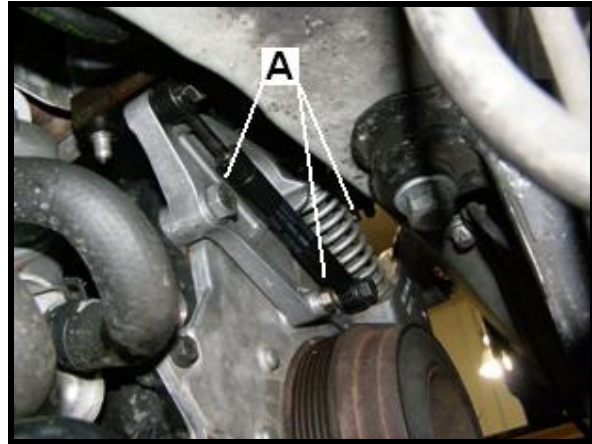

WARNING: Coolant will discharge from the engine block when removing the supercharger assembly. A blanking plug must be fitted to the dipstick tube receiving hole in the engine block to prevent coolant entering the engine.

9. Supercharger Removal

1. Disconnect PCV valve line (A).
2. Remove 4 bolts securing supercharger (B).
3. Remove supercharger and store.
4. Remove previously loosened tensioner assembly and store.

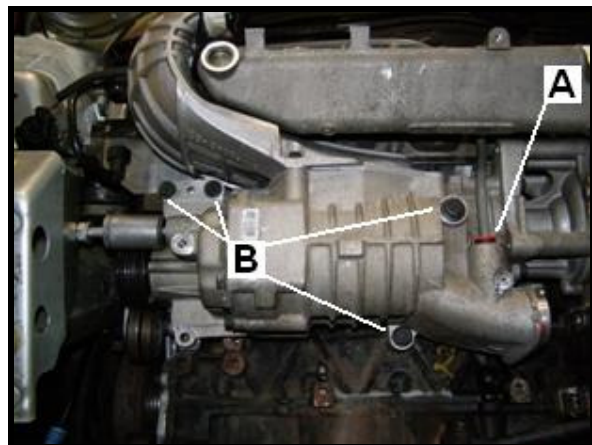

MINI COOPER S SUPERCHARGER REPLACEMENT KIT®

SECTION 2

INSTALLATION INSTRUCTIONS

SAFETY WARNING

No unauthorised service or alteration may be undertaken to the Sprintex supercharger. Installation should be carried out in a workshop which is a safe and ventilated working environment with equipment and procedures compliant with local authority guidelines and legal requirements. Installers should ensure adequate hearing, eye, and physical protection is used at all times during the installation process. Installers should take reasonable precautions to avoid fatigue and closely follow the installation instructions during every installation. Sprintex recommends installation should not be carried out unsupervised. Sprintex, its directors, employees and agents will not accept liability for damage accident or injury resulting from the installation process. Safety warnings are also provided throughout this document.

Preparation Before Assembly

WARNING: Coolant will discharge from the engine block when removing the water jacket blanking plate. A blanking plug must be fitted to the dipstick tube receiving hole in the engine block to prevent coolant entering the engine.

1. Replace water jacket blanking plate with part supplied using 2 x M6x16 long countersunk screws and 35 mm ID O-ring (BS 918). Coat O-ring with rubber grease and torque bolts to 10 Nm (7 ft-lb).

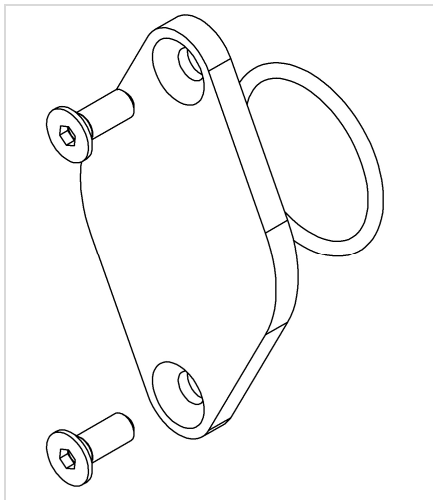
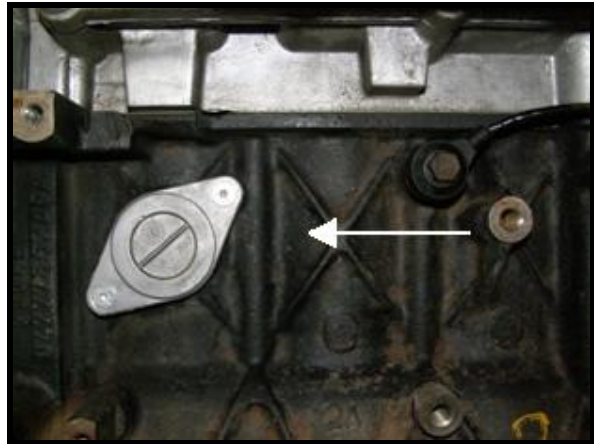

2. Remove knock sensor and store, this will be re-used during assembly.



3. Fit discharge casting supplied, to supercharger using 115mm - 4 1/2 inch ID O-ring (BS-246) and 5 x M8 x 25 long SHCS, torque to 23 Nm (17 ft-lb).

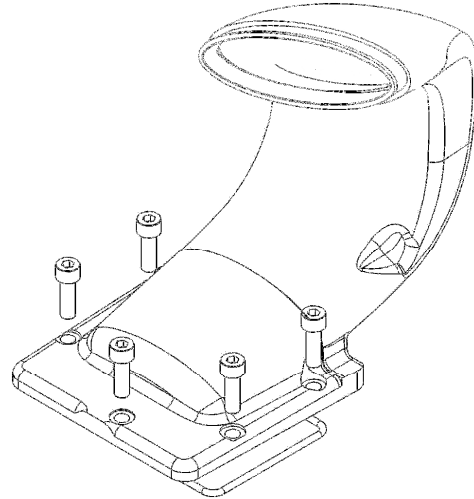

4. **Assemble components supplied, to intake casting as follows.**

- 4.1. Fit 108mm – 4 1/4 inch ID O-ring (BS-244) against inlet mating face.
- 4.2. Fit 95mm – 3 3/4 inch ID O-ring (BS-343) into groove in mating face.
- 4.3. Take 1 of 3 supplied, 8.6mm ID x 2.4 cross-section O-rings and fit into machined recess next to inlet mating face, loosely fit clamp plate using 2 of 5 supplied M5 x 12 long SHCS.
- 4.4. Take remaining two 8.6mm ID x 2.4 cross-section O-rings and three M5 x 12 long SHCS and loosely fit to recesses at throttle body end of intake casting.
- 4.5. Take previously removed hose, for bypass valve and fit to intake casting, securing at casting side only. (if original hose clamps are not in good order, replace with the two clamps supplied)
- 4.6. Take 1 of 4 supplied shoulder bolts. Firstly fit 1 of the 8 supplied 12mm OD wiring grommets over the shank of the shoulder bolt, engage bolt into the inlet casting, take another grommet and fit over protruding shank to retain the shoulder bolt to the inlet casting.

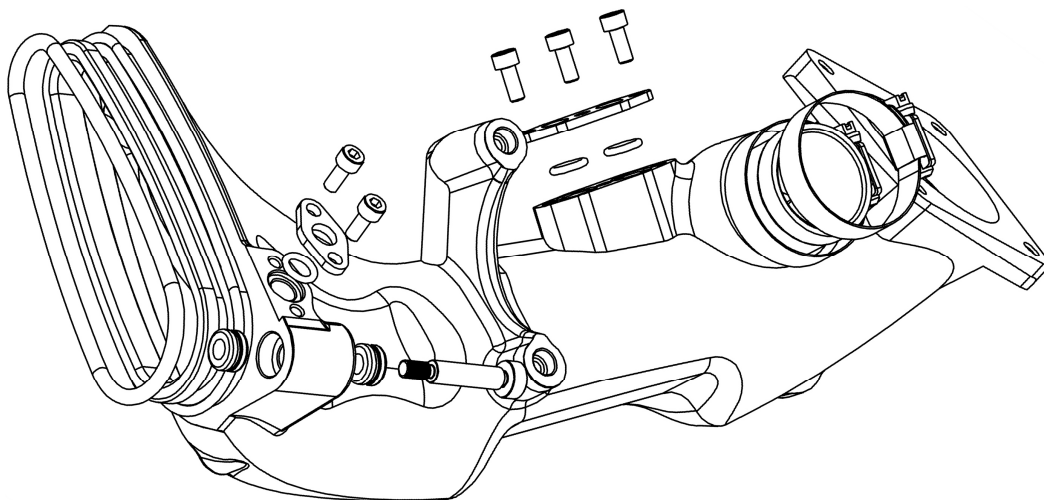

5. Take previously removed cast bypass duct and fit to intake casting assembly leaving clamp loose.



6. Take remaining shoulder bolts and grommets and fit to water pump assembly, fit 1 3/8 in ID O-ring (BS220) to pump outlet.



ASSEMBLY

1. Fit Tensioner Assembly

1. Remove 10mm bolt from original tensioner assembly and fit to new assembly supplied.
2. Fit assembly to engine using 3 of M6 x 30 long bolts supplied, torque bolts to 10 Nm (7 ft-lb).

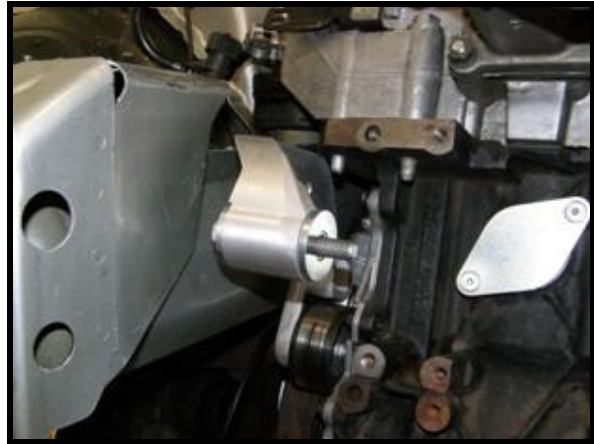

NOTE: It is important to fit the 10mm bolt into the tensioner assembly before fitting to engine as this is impossible to achieve afterwards.

2. Fit Supercharger

1. Fit supercharger to engine using 2 of M8 x 50 long SHCS (torque to 25 Nm or 18 ft-lb) and 1 of M10 x 60 long SHCS, 1 of M10 x 35 long SHCS (torque to 45 NM or 33 ft-lb).
2. Tighten tensioner main pivot bolt (torque to 45 NM or 33 ft-lb).

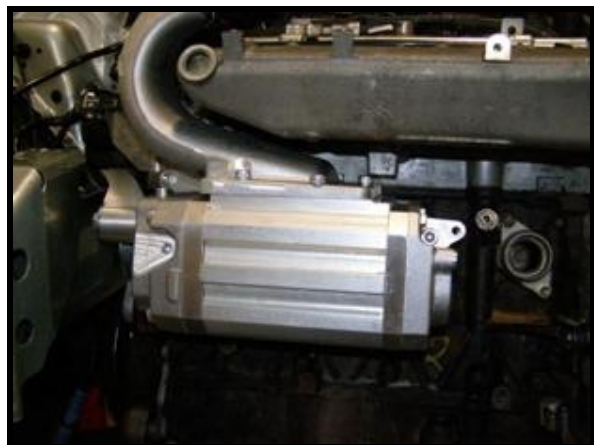

NOTE: Supercharger and bolts are a tight fit. The tensioner needs to be positioned correctly in order for the supercharger to drop into place. All bolts should be fitted before tightening, or bolt fitting will be difficult.

3. Fit Knock Sensor

1. Fit knock sensor to supercharger inlet housing using original bolt (torque to 25 Nm or 18 ft-lb).

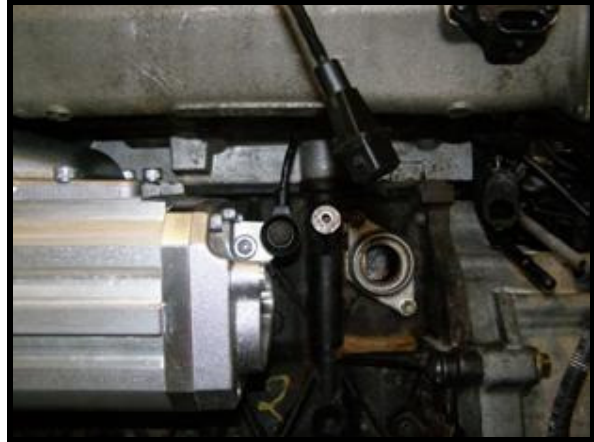

4. Fit Alternator

1. Fit alternator using original bolts M8 x 100 long (torque to 25 Nm or 18 ft-lb).
2. Plug in harness.

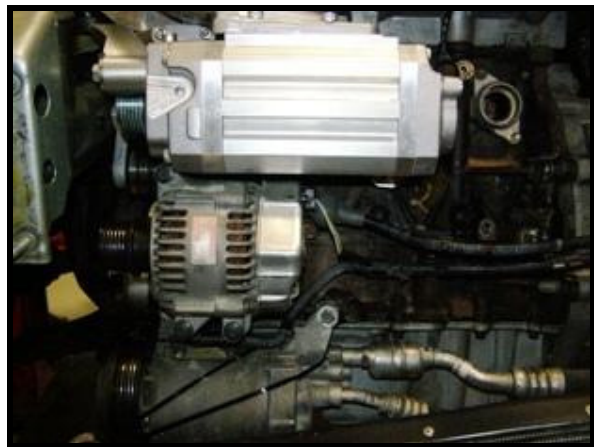

5. Fit Dipstick Tube

1. Apply rubber grease to O-ring. Re-fit dipstick tube using original bolts (torque to 25 Nm or 18 ft-lb).
2. Clip alternator harness support fittings into bracket on dipstick tube.



6. Fit Drive Belt

1. Fit drive belt as shown, leaving the idler pulley as the last component for belt to be fitted over

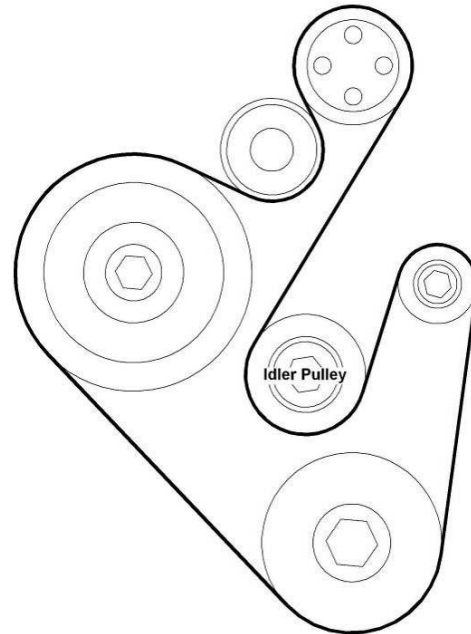

2. Take special tool supplied, working from behind right hand wheel hub, engage tool into notch machined in tensioner assembly. Using the harmonic balancer as a fulcrum, apply medium pressure to end of special tool until tensioner actuator has fully collapsed.

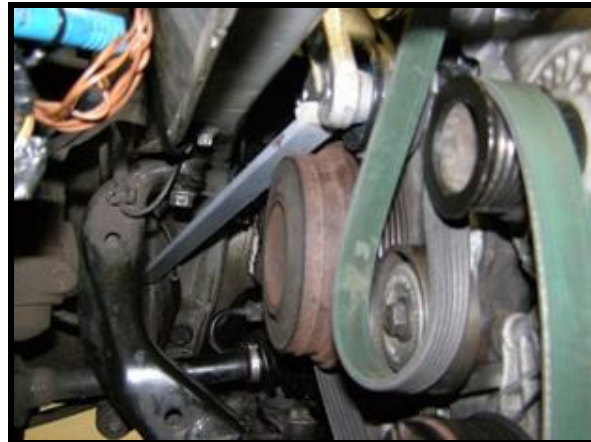

NOTE: The tensioner unit supplied is an oil dampened shock absorber. This requires medium pressure and patience to collapse far enough to engage belt

7. Fit Intake Assembly

1. Apply a thin film of sealant to both sides of the original gasket, at the bypass duct mating face.
2. Take the intake assembly (as prepared in the previous section) and engage to the inlet end of the supercharger and engine intake manifold.
3. Tighten the 3 nuts (A) of the bypass duct first (torque to 16 Nm or 12 ft-lb) leaving the shoulder bolt (B) at the supercharger intake loose until water pump has been fitted.

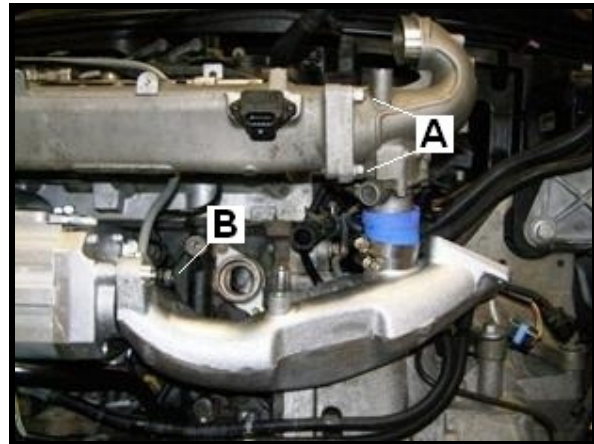

NOTE: The purpose of the shoulder bolts used in this installation is to provide a flexible mounting joint for both the water pump and inlet assembly and should be assembled as per diagram for both components.

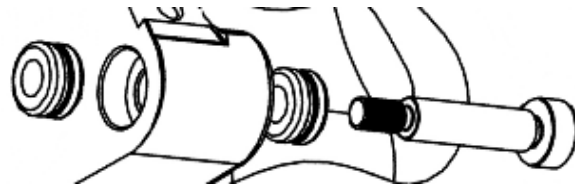

NOTE: After tightening the bypass duct, the intake assembly shoulder bolt and hose clamp must be left loose, with the throttle body end pulled downwards to provide clearance for fitting of the water pump.

CAUTION: Be careful not to use excessive amount of sealer on the bypass duct gasket. In the event that excessive sealer is used the portion that is squeezed out when duct is tightened can become free and cause supercharger failure.

8. Fit Breather and Vacuum Lines

1. Fit positive crank case breather line (A) to intake manifold and tighten screws enough to retain clamp plate and compress O-ring.
2. Fit vacuum lines (B&C) to intake manifold and tighten screws enough to retain clamp plate and compress O-ring.

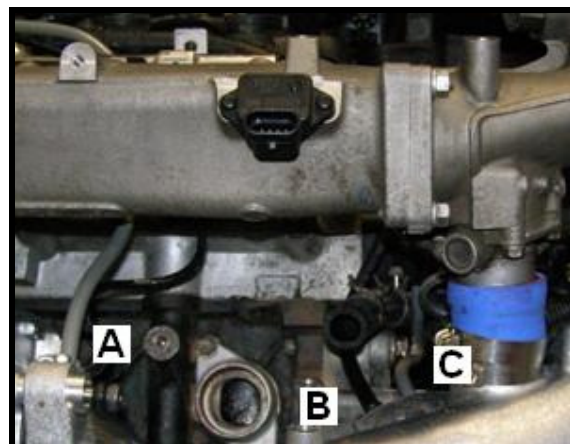

9. Fit Water Pump

1. Take water pump assembly and apply rubber grease to O-ring and hose barb.
2. Engage water pump to heater hose and water outlet flange on cylinder block.
3. Raise the throttle body end of inlet assembly and tighten inlet shoulder bolt (torque to 10 Nm or 7 ft-lb).
4. Tighten all 3 water pump shoulder bolts in stages, starting at top left working clockwise until water pump is secure (torque to 10 Nm or 7 ft-lb).
5. Secure heater hose with original clamp so that the tangs of the clamp are orientated at 10 o'clock to avoid chafing against top radiator hose.
6. Tighten bypass hose clamp last, as this allows the water pump to be the primary positional locator.



10. Plug in Electrical Components

1. Locate the wiring connectors for the MAP sensor and Knock sensor; feed the connectors between the bypass hose and engine block above where the top radiator hose will be fitted and plug in.
2. Feed the water pump wire connector through the same space in opposite direction so that water pump plug terminates near the MAP sensor at the end of the engine and secure to MAP and Knock sensor harness.



11. Water Pump Relay Harness

- A. Red with eyelet, 12 V supply.
- B. Green, relay switching.
- C. Black with eyelet, relay ground

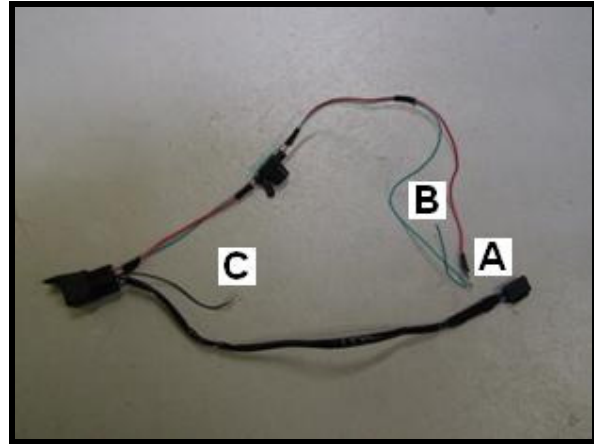

12. Water Pump Relay Mounting

1. Mount relay to left hand inner guard, using self tapping screw.
2. Secure wire (D) relay earth, to existing earth point.
3. Plug in water pump connector.



13. Water Pump Wiring Connections.

1. Connect Red wire with eyelet at location (A)
2. Tee into Red/Blue wire at location 5 with Green wire.

NOTE: Location (A) is permanent 12 V. Red/Blue at location 5 is switched 12V Use a multi meter to determine that location 5 is switched.

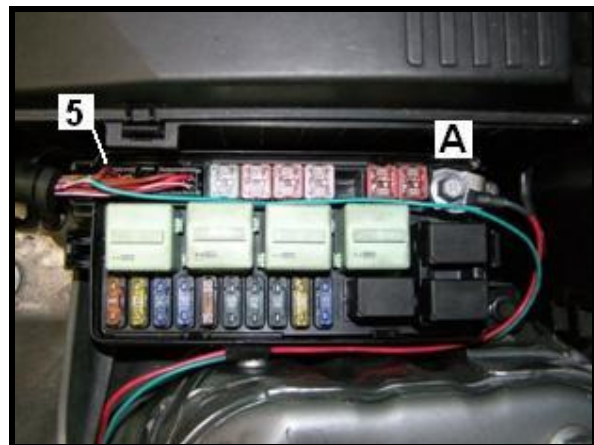
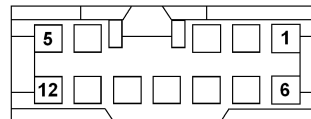

14. Fit radiator hoses

1. Using original hoses and clamps, fit top and bottom radiator hoses ensuring that there is a clear path between the hoses and other components, paying particular attention to the heater hose outlet clamp at the water pump.



15. Fit Throttle Body

1. Fit throttle assembly to supercharger intake duct and tighten bolts (C) (torque to 9 Nm or 7 ft-lb).
2. Attach electrical harness connector (A) and fuel tank vent line (B)

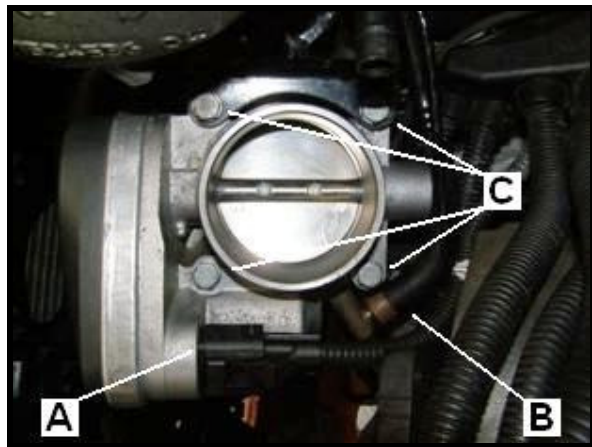

16. Fit Inlet Air Hose

1. Fit inlet air pipe to throttle body and secure with original clamp



17. Fit Air Box Assembly and Engine Control Unit

1. Replace air box assembly into its original location and secure with previously removed bolt.
2. Tighten hose clamps
3. Fit cold air intake duct.
4. Slot ECU into its original location and engage plugs

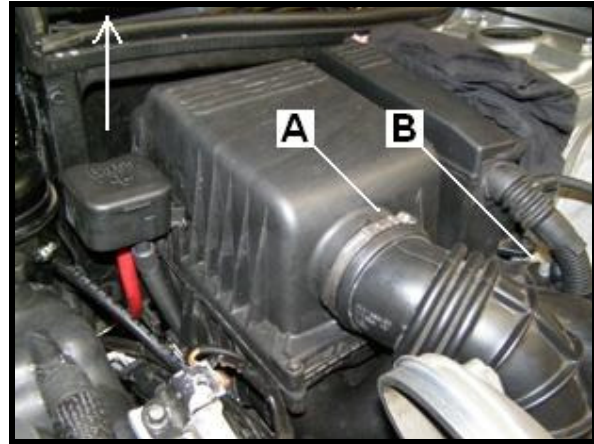

18. Fit Intercooler Assembly

1. Starting at left hand side, loosely fit bellows bridge clamps (A).
2. Engage intercooler to left hand side and take up clamps to loosely secure intercooler.
3. Repeat process for right hand side making shore both bellows are nested correctly and tighten clamps.
4. Fit intercooler mounting brackets (B), include securing knock sensor plug retaining bracket, to right hand front intercooler bracket.
5. Fit and secure intercooler cover.

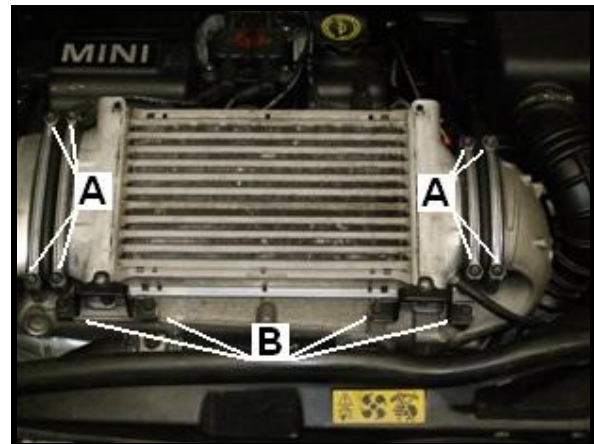

19. Replace Modular Front End

1. Install two M8 X 100 bolts (B) in left and right bumper support members.
2. Support modular front end on bolts and attach air-conditioning condenser to radiator with M6 x 12 bolts (torque to 6Nm or 53 inch pound).

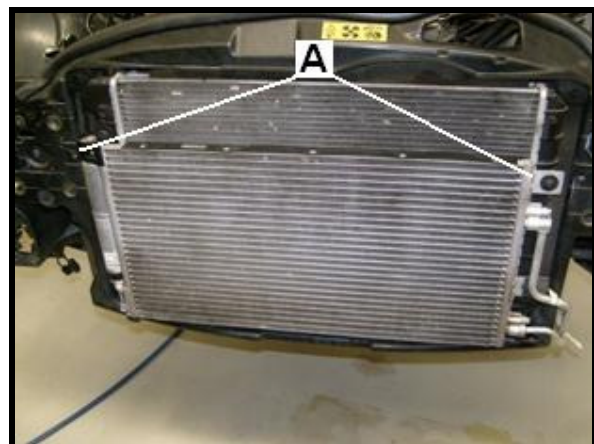

3. Reconnect wiring to fog lamps.
4. Locate and connect wiring for horns and cooling fan.
5. Relocate and secure air conditioning gassing point.
6. Fit top and bottom radiator hoses.
7. Slide modular front into place and engage cold air inlet duct (C).
8. Secure top radiator hose retaining bracket (A) to intake manifold.

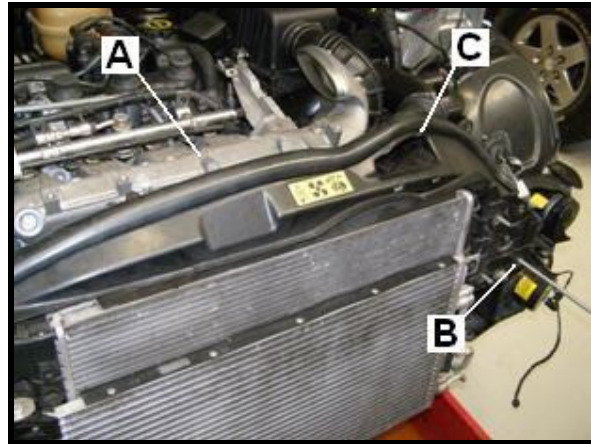

9. Remove M8 X 100 bolts.
10. Working underneath car, relace crush tubes and secure with original bolts (A). (torque to 100 Nm or 74 ft-lb)
11. Secure modular front end using original bolt (B). (torque to 5 Nm or 44 inch pound)

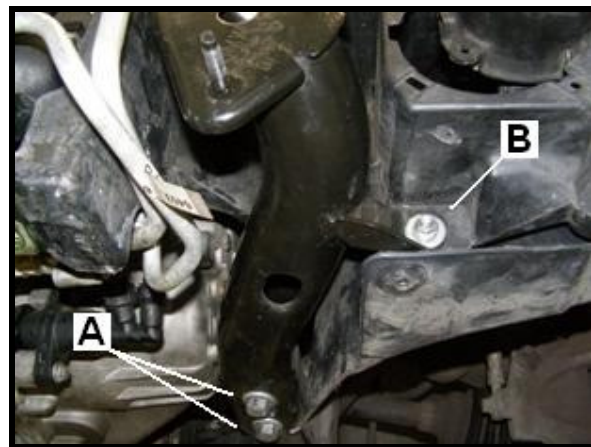

20. Fit Front Bumper Carrier.

1. Fit front bumper carrier and secure with original nuts (A) and bolts (B). (torque to 22 Nm or 16 ft-lb)
2. Feed electrical harness for outside temperature sensor through access hole for bottom left nut.

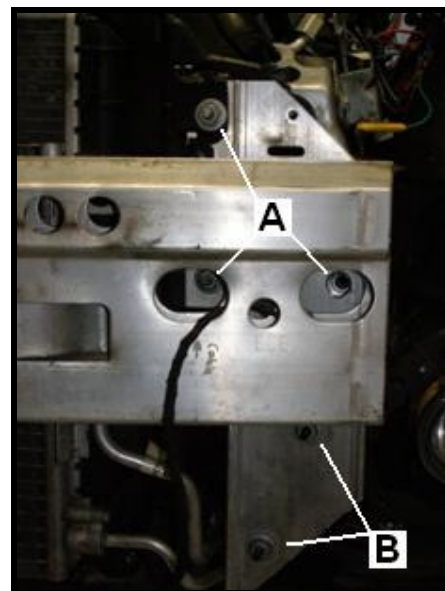

21. Reconnect Battery

NOTE: Battery Positive terminal (B) should always be connected first.

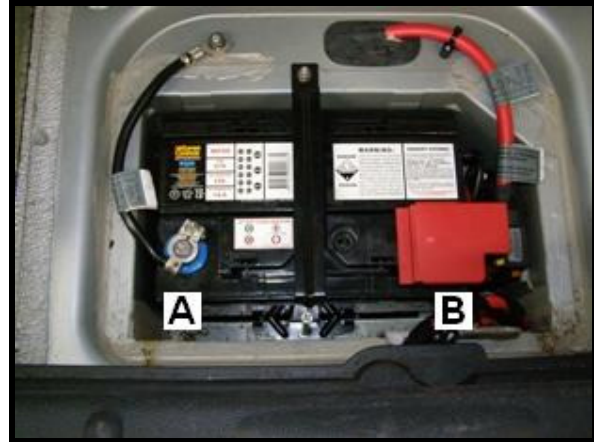

22. Fill and Bleed Cooling System.

1. Release bleed screw 1, located in the heater hose line just forward of the thermostat housing.
2. Release bleed screw 2, located in the plastic junction piece in the top radiator hose.
3. Switch ignition to the on position and dial the heater control knob to hottest so that the heating flow circuit is open with fan on low.
4. Slowly fill the system at the expansion tank, paying attention to bleed screw 1. Once you are confident that there is no more air at bleed screw 1 lock off bleed screw.
5. Move to bleed screw 2, once air has stopped purging from bleed screw 2 lock off bleed screw.
6. Continue to fill system to the required level, continually checking the level is maintained. The system will self purge if the previous steps have been successful.
7. After the system has had time to self purge re-visit each of the bleed screws to confirm all of the air has been removed from the system.
8. Fit and tighten the expansion tank lid. Start and run engine keeping an eye on the temperature gauge and coolant level, once the temperature gauge has reached the half way mark, stop engine and let rest with the ignition in the on position so that the electric pump continues to circulate while checking for coolant leaks.

Note: Do not run the engine for sustained periods with the expansion tank lid removed. This will allow the coolant to boil in the cylinder block giving a false impression of air in the system.

Caution:

Do not run engine until steps 1 to 7 have been completed successfully as scolding and or engine damage may occur

23. Fit Front Bumper Cover

1. Support bumper and reconnect turn signals and outside temperature sensor.
2. Position bumper secure in place with bolts (A) & (B).

3. Fit Splash Shield Under Engine

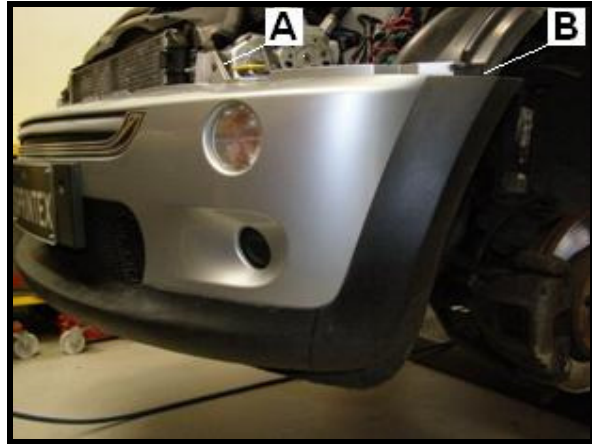

MINI COOPER S SUPERCHARGER REPLACEMENT KIT®

SECTION 3

PRE TEST-DRIVE INSPECTION

SAFETY WARNING

Ensure adequate steps are taken to prevent injury, spillage or fire should any of the required installation steps not have been carried out to specification.

1. Pre-Start Inspection

Ensure coolant is at correct level.

Ensure engine oil is at correct level.

Ensure vehicle has fresh 95 Octane fuel.

Ensure the belt is aligned.

SAFETY WARNING: Ensure adequate steps are taken to prevent injury, spillage or fire should any of the required installation steps not have been carried out to specification.

Engine Warm Up

Start engine and allow to run, until engine reaches normal operating temperature.

Check for oil leaks.

Road Test Vehicle

Road test vehicle.

Recheck all joints and connections for leaks –rectify as needed.

MINI COOPER S SUPERCHARGER REPLACEMENT KIT®

SECTION 4

MAINTENANCE INSTRUCTIONS

1. Supercharger Drive Belt Replacement

It is recommended that the supercharger drive belt be checked at every regular service and be replaced at 50,000 km or 2 years, whichever occurs first.

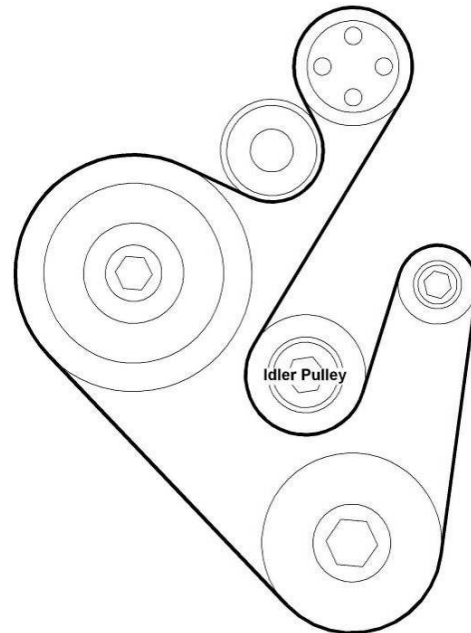

Take special tool supplied, working from behind right hand wheel hub, engage tool into notch machined in tensioner assembly. Using the harmonic balancer as a fulcrum, apply medium pressure to end of special tool until tensioner actuator has fully collapsed.



NOTE: The tensioner unit supplied is an oil dampened shock absorber. This requires medium pressure and patience to collapse far enough to engage belt

Supercharger Removal

Refer to section 1

DISASSEMBLY INSTRUCTIONS, Pages 15 to 23

Supercharger Lubrication Service

Drain and replace oil every 50,000 km or 30,000 miles

Place a suitable funnel under drain plug at front side bottom of cover. Remove fill plug top centre of cover to allow complete draining. Remove bottom plug and drain.

Replace copper sealing gasket on drain plug, fit plug and torque to 10 Nm or 7 ft-lb.

Use Redline 75W/90NS High Performance gear oil or equivalent and **fill with exactly 111 millilitres' or 3.77 US fluid ounces.**

Replace copper sealing gasket on fill plug, fit plug and torque to 10 Nm or 7 ft-lb.

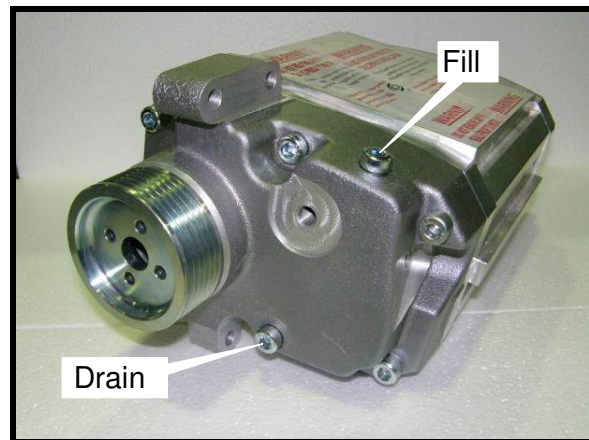

Supercharger Service

Sprintex recommends that the supercharger be serviced every 150,000 km. This entails a replacement of all bearings and seals.